

Silicon NPN Transistor

BF194

HF Transistor

30V / 30mA

DATASHEET

OEM – Siemens

Source: Siemens Databook 1970/71

BF 194, BF 195

NPN-Hochfrequenz-Transistoren

BF 194 und BF 195 sind epitaktische NPN-Silizium-Hochfrequenz-Transistoren in Planar-Technik in Kunststoffumhüllung (SOT-25).

BF 194: Zum Einsatz in AM- /FM-ZF-Verstärker sowie für Eingangsstufen im Kurz-, Mittel- und Langwellenbereich.

BF 195: Zum Einsatz in Vor-, Misch- und Oszillatorstufen bis in den UKW-Bereich.

Typ	Bestellnummer
BF 194	Q62702-F147
BF 195	Q62702-F148

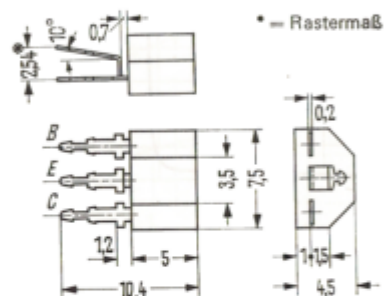

Einbauhinweise siehe Vorwort Seite 60

Gewicht 0,33 g

Maße in mm

Grenzdaten

	BF 194	BF 195		
Kollektor-Basis-Spannung	U_{CBO}	30	30	V
Kollektor-Emitter-Spannung	U_{CEO}	20	20	V
Emitter-Basis-Spannung	U_{EBO}	5	5	V
Kollektorstrom	I_C	30	30	mA
Sperrschichttemperatur	T_j	125	125	°C
Lagertemperatur	T_a	-65 bis +125	-65 bis +125	°C
Gesamtverlustleistung	P_{tot}	220	220	mW

Wärmewiderstand

Kollektorsperrschicht – Luft	R_{thJU}	≤ 450	≤ 450	grd/W
------------------------------	------------	-------	-------	-------

BF 194, BF 195

Statische Kenndaten ($T_U = 25^\circ\text{C}$)		BF 194	BF 195	
Basis-Emitterspannung ¹⁾ ($U_{CE} = 10\text{ V}; I_C = 1\text{ mA}$)	U_{BE}	0,68	0,69	V
		(0,64 bis 0,71)	(0,65 bis 0,73)	V
Basisstrom ($U_{CE} = 10\text{ V}; I_C = 1\text{ mA}$)	I_B	8,7	15	μA
		(4,5 bis 15)	(8 bis 28)	
Gleichstromverstärkung ($U_{CE} = 10\text{ V}; I_C = 1\text{ mA}$)	B	115	67	

Dynamische Kenndaten ($T_U = 25^\circ\text{C}$)		BF 194	BF 195	
Transitfrequenz ($U_{CE} = 10\text{ V}; I_C = 1\text{ mA}$)	f_T	260	200	MHz
Rauschmaß ($U_{CE} = 10\text{ V}; I_C = 1\text{ mA}$)		—	—	
bei $f = 200\text{ kHz}$, $g_g = 2\text{ mS}^2$)	F	1,5	—	dB
bei $f = 1\text{ MHz}$, $g_g = 1,5\text{ mS}^2$)	F	1,2	—	dB
bei $f = 1\text{ MHz}$, $g_g = 20\text{ mS}^2$)	F	—	3,5	dB
bei $f = 100\text{ MHz}$, $g_g = 10\text{ mS}^2$)	F	4	4	dB
Mischrauschmaß ($U_{CE} = 10\text{ V}; I_C = 1\text{ mA}$)				
bei $f = 200\text{ kHz}$, $g_g = 0,6\text{ mS}^2$)	F_C	3	—	dB
bei $f = 1\text{ MHz}$, $g_g = 1,2\text{ mS}^2$)	F_C	2	—	dB
bei $f = 200\text{ kHz}$, $g_g = 1,2\text{ mS}^2$)	F_C	—	4	dB
bei $f = 1\text{ MHz}$, $g_g = 1,5\text{ mS}^2$)	F_C	—	2,5	dB
Rückwirkungskapazität $U_{CE} = 10\text{ V}; I_C = 1\text{ mA};$ $f = 450\text{ kHz}$	$-C_{12e}$	0,95	0,95	pF

¹⁾ $\Delta U_{BE}/\Delta T \approx -1,7\text{ mV/}^\circ\text{C}$

²⁾ $g_g = \text{Generatorleitwert} \left(\frac{1}{R_g} \right)$

BF 194, BF 195**Dynamische Kenndaten ($T_U = 25^\circ\text{C}$) BF 194****Vierpolgrößen**Arbeitspunkt: ($U_{CB} = 10\text{ V}$; $-I_E = 1\text{ mA}$)

$f = 450\text{ kHz}$:	$g_{11e} = 0,3\text{ mS}$	$ y_{12e} = 2,7\text{ }\mu\text{S}$	$ y_{21e} = 35\text{ mS}$	$g_{22e} = 4\text{ }\mu\text{S}$
	$b_{11e} = 0,07\text{ mS}$	$-\varphi_{12e} = 90^\circ$	$-\varphi_{21e} = 0^\circ$	$b_{22e} = 4\text{ }\mu\text{S}$
	$C_{11e} = 25\text{ pF}$			$C_{22e} = 1,4\text{ pF}$
$f = 10,7\text{ MHz}$:	$g_{11e} = 0,45\text{ mS}$	$ y_{12e} = 65\text{ }\mu\text{S}$	$ y_{21e} = 35\text{ mS}$	$g_{22e} = 5,5\text{ }\mu\text{S}$
	$b_{11e} = 1,7\text{ mS}$	$-\varphi_{12e} = 90^\circ$	$-\varphi_{21e} = 5^\circ$	$b_{22e} = 0,1\text{ mS}$
	$C_{11e} = 25\text{ pF}$			$C_{22e} = 1,6\text{ pF}$
$f = 35\text{ MHz}$:	$g_{11e} = 0,85\text{ mS}$	$ y_{12e} = 185\text{ }\mu\text{S}$	$ y_{21e} = 35\text{ mS}$	$g_{22e} = 6\text{ }\mu\text{S}$
	$b_{11e} = 4,2\text{ mS}$	$-\varphi_{12e} = 100^\circ$	$-\varphi_{21e} = 15^\circ$	$b_{22e} = 0,35\text{ mS}$
	$C_{11e} = 19\text{ pF}$			$C_{22e} = 1,6\text{ pF}$

Dynamische Kenndaten ($T_U = 25^\circ\text{C}$) BF 195**Vierpolgrößen**Arbeitspunkt: ($U_{CB} = 10\text{ V}$; $-I_E = 1\text{ mA}$)

$f = 450\text{ kHz}$:	$g_{11e} = 0,4\text{ mS}$	$ y_{12e} = 2,7\text{ }\mu\text{S}$	$ y_{21e} = 35\text{ mS}$	$g_{22e} = 4\text{ }\mu\text{S}$
	$b_{11e} = 0,07\text{ mS}$	$-\varphi_{12e} = 90^\circ$	$-\varphi_{21e} = 0^\circ$	$b_{22e} = 4\text{ }\mu\text{S}$
	$C_{11e} = 25\text{ pF}$			$C_{22e} = 1,4\text{ pF}$
$f = 10,7\text{ MHz}$:	$g_{11e} = 0,55\text{ mS}$	$ y_{12e} = 65\text{ }\mu\text{S}$	$ y_{21e} = 35\text{ mS}$	$g_{22e} = 4,5\text{ }\mu\text{S}$
	$b_{11e} = 1,95\text{ mS}$	$-\varphi_{12e} = 90^\circ$	$-\varphi_{21e} = 5^\circ$	$b_{22e} = 0,1\text{ mS}$
	$C_{11e} = 29\text{ pF}$			$C_{22e} = 1,6\text{ pF}$
$f = 35\text{ MHz}$:	$g_{11e} = 1,1\text{ mS}$	$ y_{12e} = 185\text{ }\mu\text{S}$	$ y_{21e} = 35\text{ mS}$	$g_{22e} = 5\text{ }\mu\text{S}$
	$b_{11e} = 4,85\text{ mS}$	$-\varphi_{12e} = 100^\circ$	$-\varphi_{21e} = 15^\circ$	$b_{22e} = 0,35\text{ mS}$
	$C_{11e} = 22\text{ pF}$			$C_{22e} = 1,6\text{ pF}$
$f = 100\text{ MHz}$:	$g_{11e} = 6\text{ mS}$	$ y_{12e} = 0,59\text{ mS}$	$ y_{21e} = 31\text{ mS}$	$g_{22e} = 12\text{ }\mu\text{S}$
	$b_{11e} = 13,8\text{ mS}$	$-\varphi_{12e} = 115^\circ$	$-\varphi_{21e} = 30^\circ$	$b_{22e} = 1\text{ mS}$
	$C_{11e} = 22\text{ pF}$			$C_{22e} = 1,6\text{ pF}$
	$g_{11b} = 33\text{ mS}$	$ y_{12b} = 480\text{ }\mu\text{S}$	$ y_{21b} = 31\text{ mS}$	$g_{22b} = 12\text{ }\mu\text{S}$
	$-b_{11b} = 5,6\text{ mS}$	$-\varphi_{12b} = 92^\circ$	$-\varphi_{21b} = 150^\circ$	$b_{22b} = 1\text{ mS}$
	$-C_{11b} = 9\text{ pF}$			$C_{22b} = 1,6\text{ pF}$

BF 194, BF 195

Temperaturabhängigkeit der
zulässigen Gesamtverlustleistung
 $P_{\text{tot}} = f(T_U)$

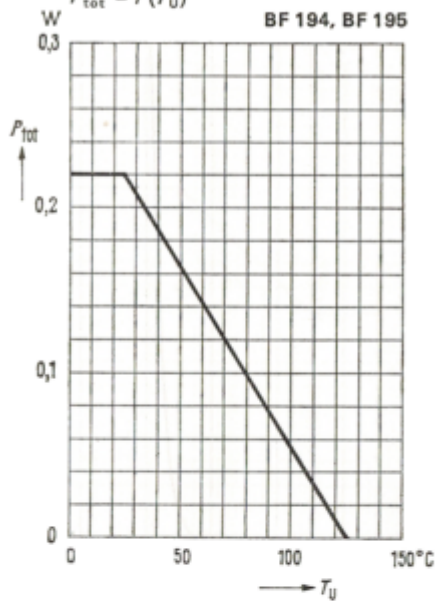

Stromverstärkung $B = f(I_C)$
 $U_{\text{CE}} = 10 \text{ V}; T_U = 25 \text{ °C}$

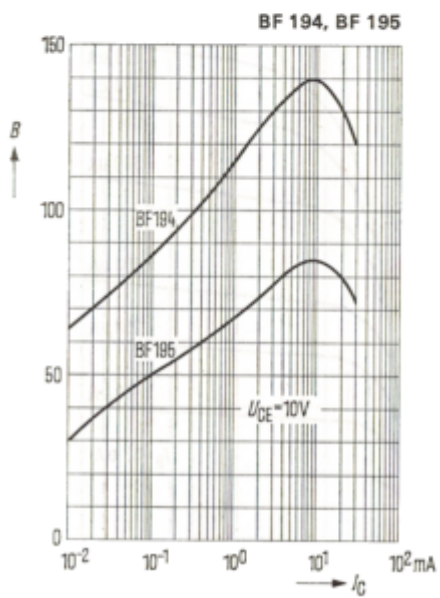

Kollektorstrom $I_C = f(I_B)$

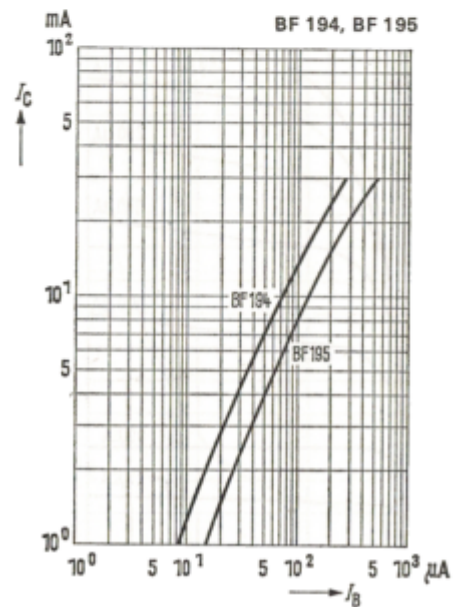

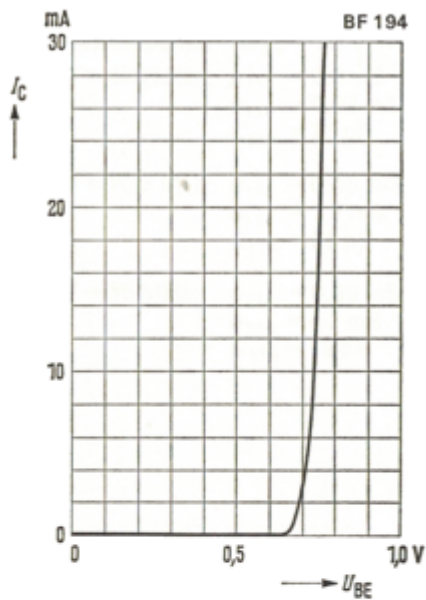
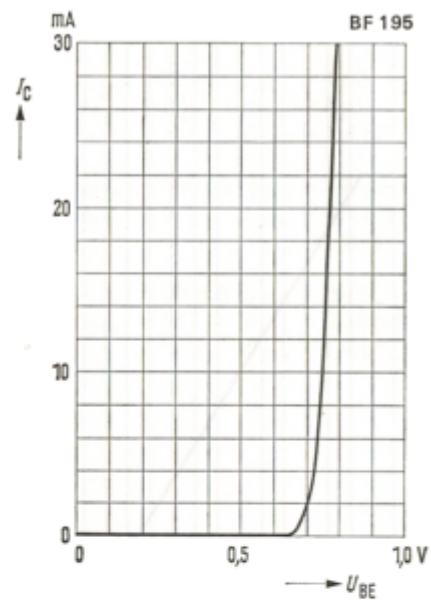
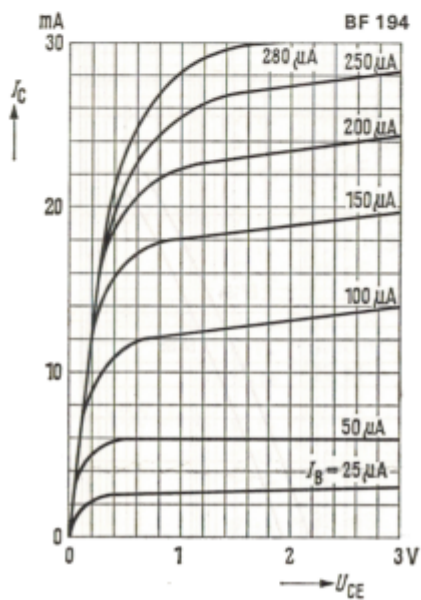
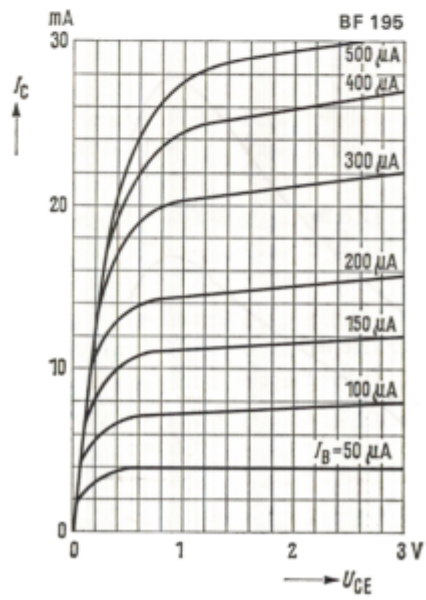
BF 194, BF 195Eingangskennlinie $I_C = f(U_{BE})$
 $U_{CE} = 2\text{ V}$ Eingangskennlinie $I_C = f(U_{BE})$
 $U_{CE} = 2\text{ V}$ Ausgangskennlinien $I_C = f(U_{CE})$
 $I_B = \text{Parameter}$ Ausgangskennlinien $I_C = f(U_{CE})$
 $I_B = \text{Parameter}$ 

BF 194, BF 195

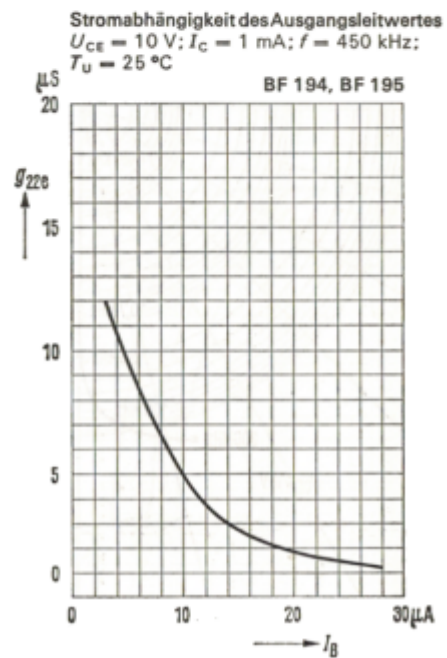
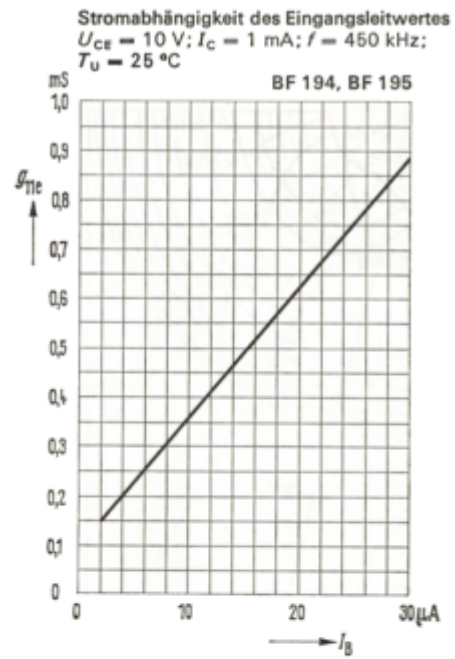
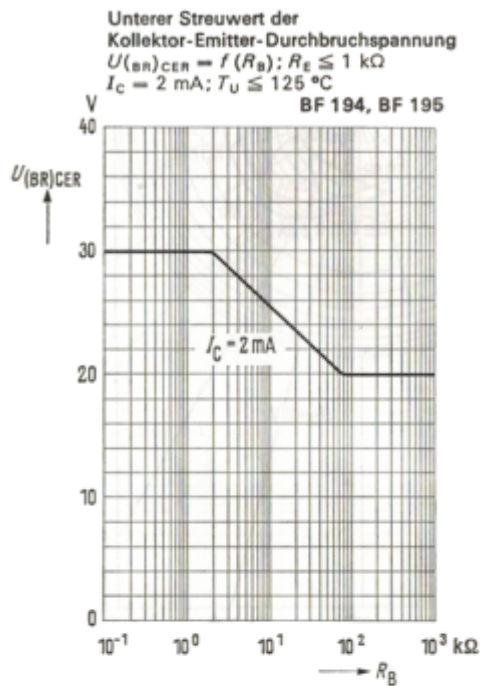

BF 194, BF 195

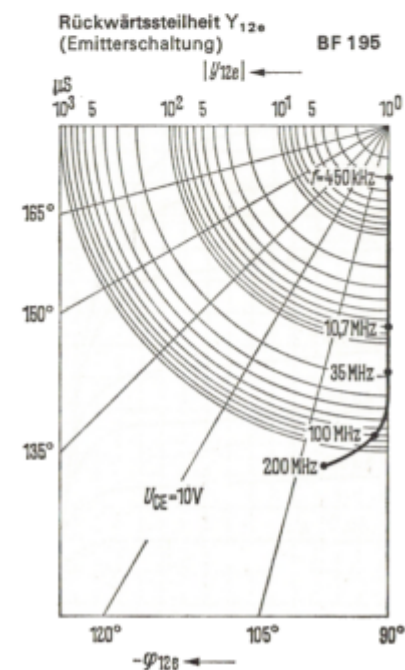
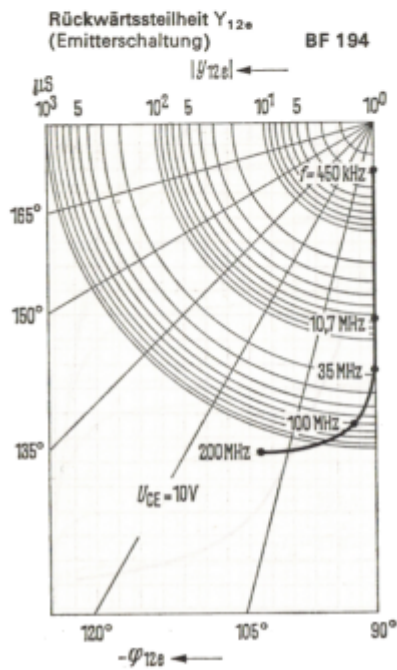
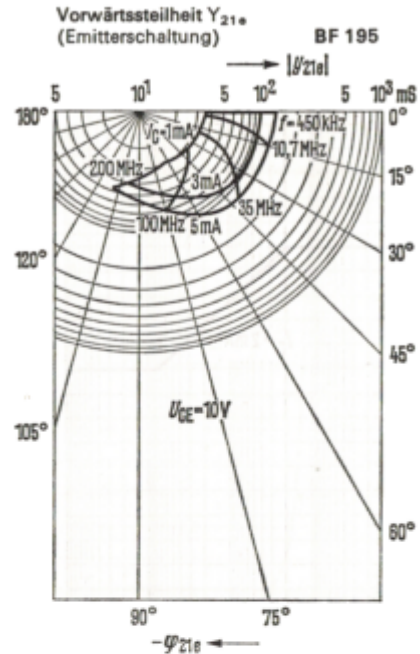
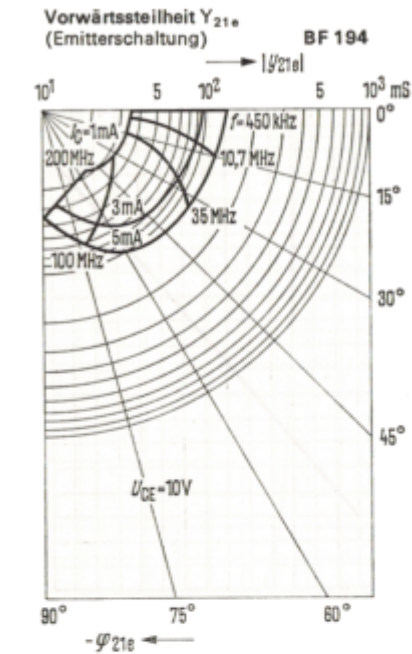

BF 194, BF 195

Eingangsleitwert Y_{11e}
(Emitterschaltung)

BF 194

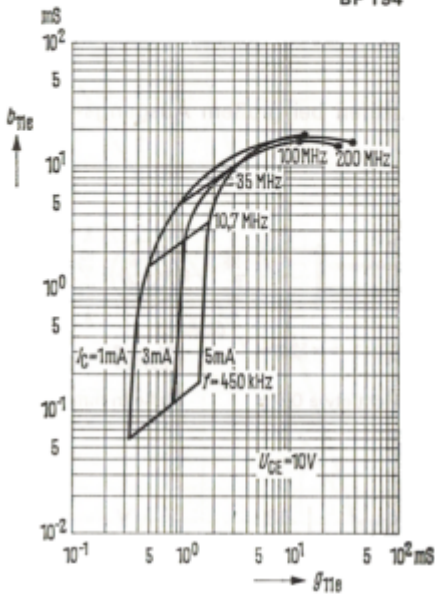

Eingangsleitwert Y_{11e}
(Emitterschaltung)

BF 195

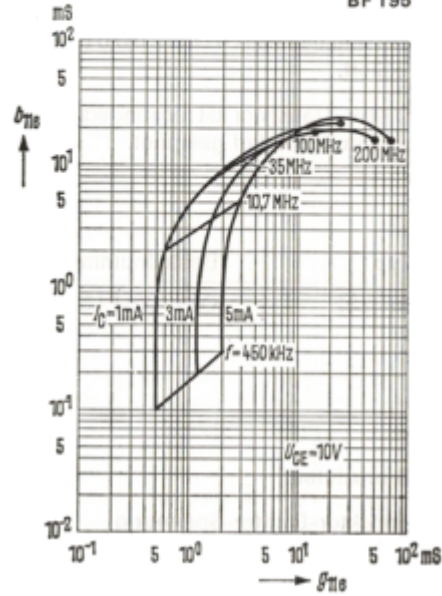

Ausgangsleitwert Y_{22e}
(Emitterschaltung)

BF 194

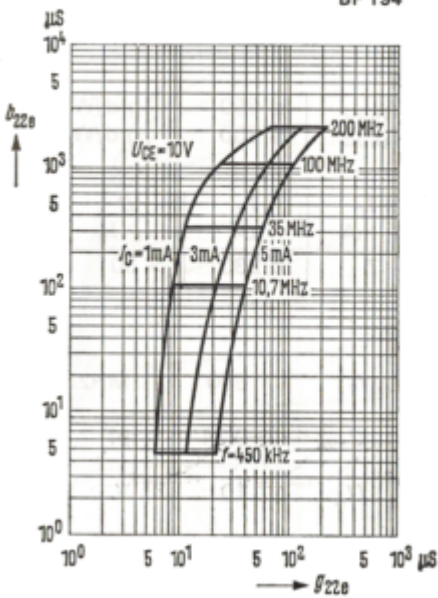

Ausgangsleitwert Y_{22e}
(Emitterschaltung)

BF 195

